

# Solid matter loading systems for biogas plants

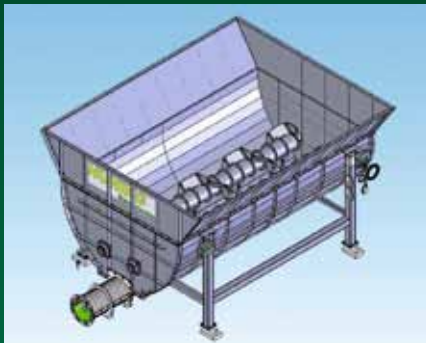

*SBCV series from 13 to 33 cbm*

*Universal scope of application for the widest possible range  
of installation scenarios and substrates requiring low power*

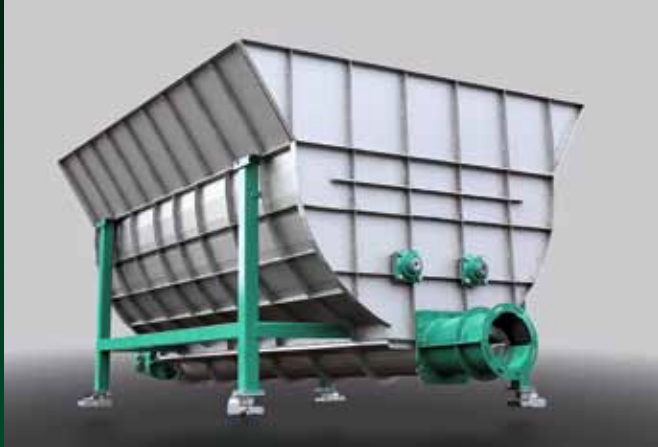

SBCV-13 cbm

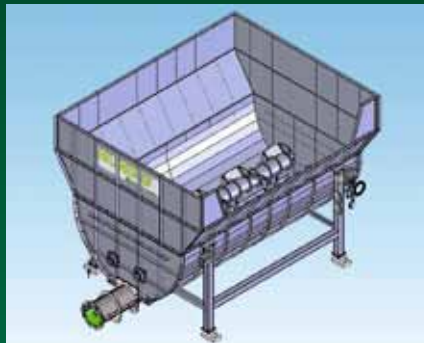

SBCV-16 cbm  
Three-way attachment



SBCV-19 cbm  
Four-way attachment



SBCV-22 cbm  
Three-way attachment



SBCV-25/33 cbm  
Four-way attachment

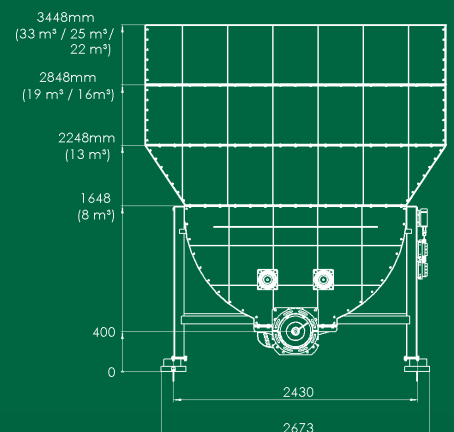

## All the benefit at a glance:

- ➔ 2 agitators with exchangeable tools to minimise the risk of bridging from unsuitable substrate properties
- ➔ Reliable dosing
- ➔ Precise balance of loading volumes thanks to optimal system weighting
- ➔ Surface coming into contact with products designed in high-grade steel type 1.4301
- ➔ Highly cost-effective thanks to long life cycle and low investment costs
- ➔ Conveyance via direct loading, high conveyance spiral conveyor connection to pump system
- ➔ Low energy consumption

PART OF THE  
HUNING GROUP

HUNING Maschinenbau GmbH • Wellingholzhausener Straße, D-49324 Melle  
Tel. +49 (0) 54 22/6 08-2 60 • Fax +49 (0) 54 22/6 08-2 63  
info@huning-maschinenbau.de • www.huning-maschinenbau.de